

PULEGGE DENTATE TIPO T - MOZZO GREZZO

PASSO 10mm PER CINGHIA LARGA 50mm

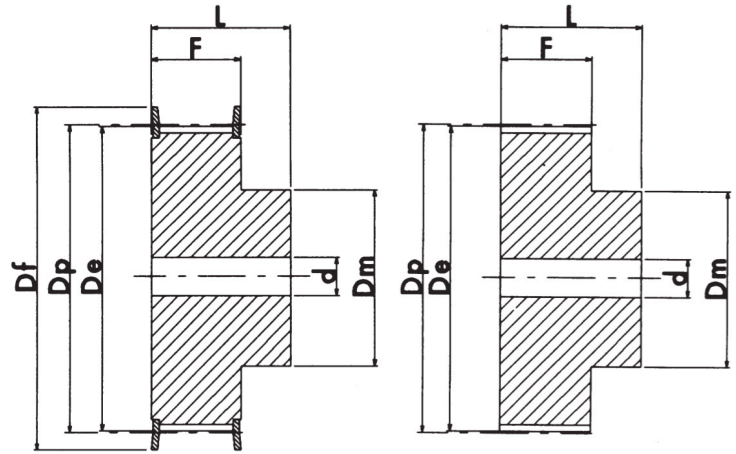

Materiale: Alluminio

ESECUZIONE 1F

ESECUZIONE 2

N°Denti	Esecuzione	Flangia	L	Dp	De	Df	Dm	F	d	Codice
			mm	mm	mm	mm	mm	mm	mm	
18	1F	✓	66	57.29	55.45	60	40	56	10	66T10Z18F
19	1F	✓	66	60.48	58.65	66	44	56	10	66T10Z19F
20	1F	✓	66	63.66	61.80	66	46	56	12	66T10Z20F
22	1F	✓	66	70.03	68.20	75	52	56	12	66T10Z22F
24	1F	✓	66	76.39	74.55	83	58	56	12	66T10Z24F
25	1F	✓	66	79.58	77.75	83	60	56	12	66T10Z25F
26	1F	✓	66	82.76	80.90	87	60	56	12	66T10Z26F
27	1F	✓	66	85.95	84.10	91	60	56	12	66T10Z27F
28	1F	✓	66	89.12	87.25	93	60	56	12	66T10Z28F
30	1F	✓	66	95.49	93.65	102	60	56	12	66T10Z30F
32	1F	✓	66	101.86	100.00	106	65	56	12	66T10Z32F
36	1F	✓	66	114.59	112.75	119	70	56	16	66T10Z36F
40	1F	✓	66	127.32	125.45	131	80	56	16	66T10Z40F
44	2		66	140.05	138.20	-	88	56	16	66T10Z44
48	2		66	152.78	150.95	-	95	56	16	66T10Z48
60	2		66	190.98	189.10	-	110	56	16	66T10Z60

